

Required Tools: Rebar, 300 ft tape measure, 100 ft Tape measure, hammer, a buddy.

Notes: All the flags next to gates have the option of being stand alone feather flags OR flags on the end of a gate. The start blocks can be placed anywhere you deem safe for your field. A suggestion would be by the 4 gates in a row.

Step 1:

Pound a rebar or place holder for your origin, or 0,0 mark.

Extend the tape measure as straight as you can for 168 feet and lay on the ground. Place a marker at the 168ft mark.

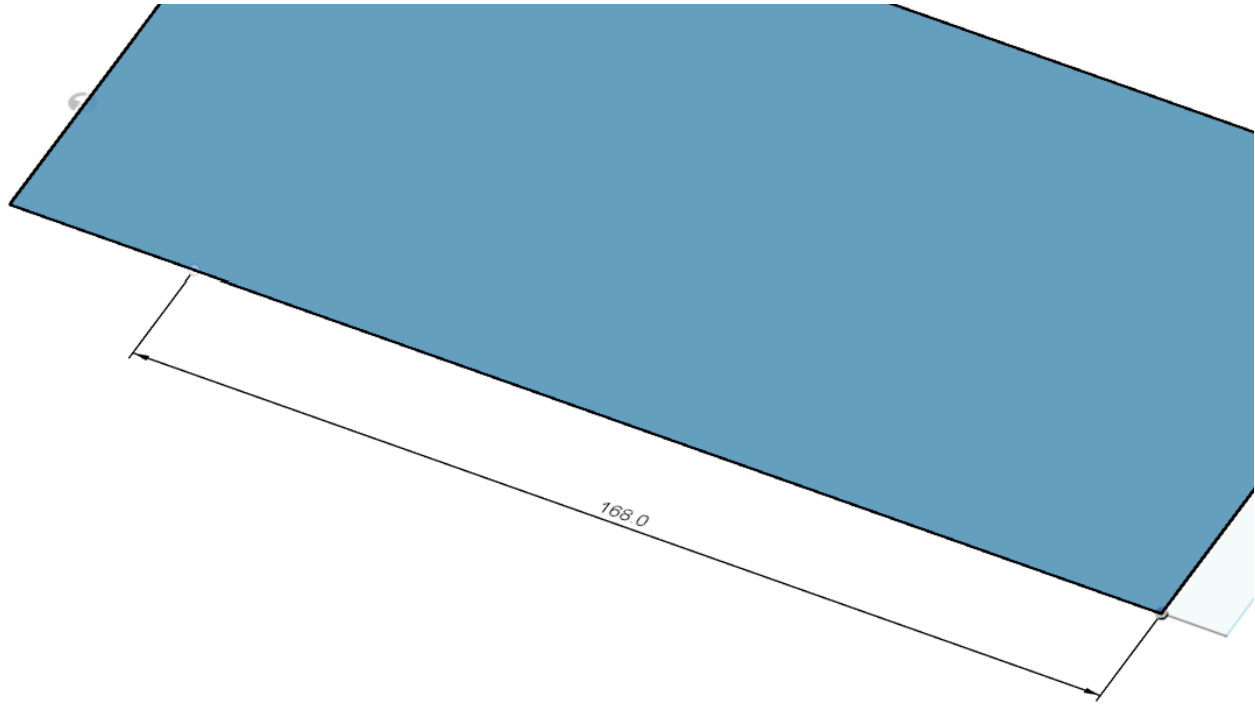

Step 2

Place a Gate leg rebar at the 84' mark as well along this tape measure.

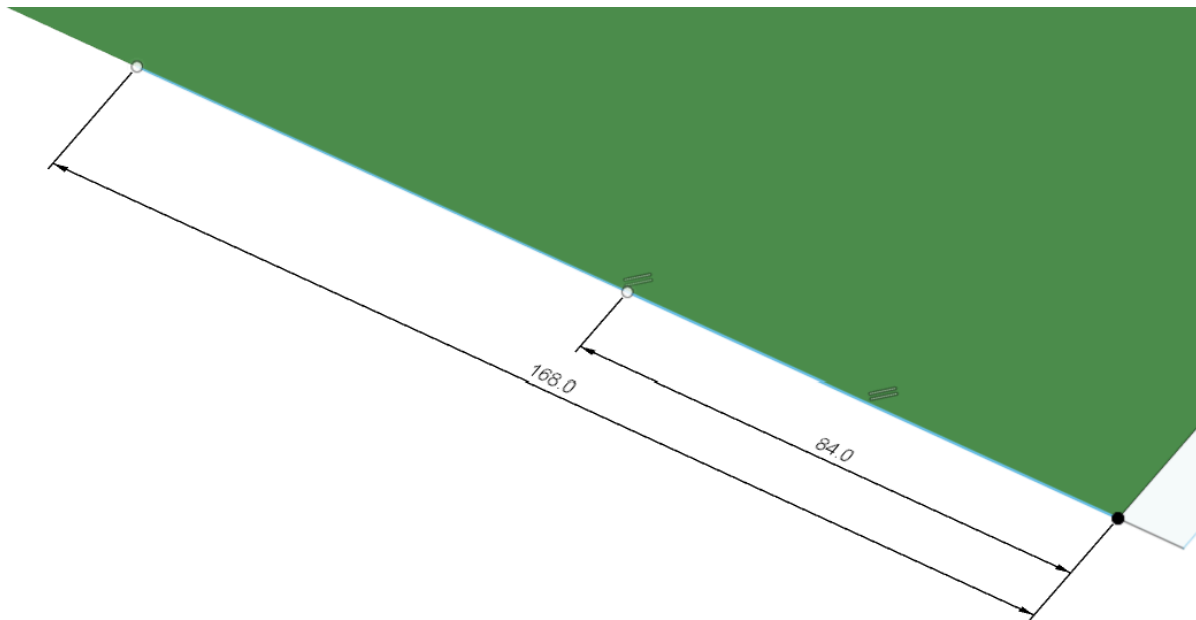

### Step 3

Now we will square the track. From the 84' rebar walk out 120.9 feet. Then with the other tape measure, go to your zero and walk out 87 feet. Where these 2 meet place a marker. Also place a marker at 31 feet, and a gate leg rebar at 60 feet and a marker at 84 feet.

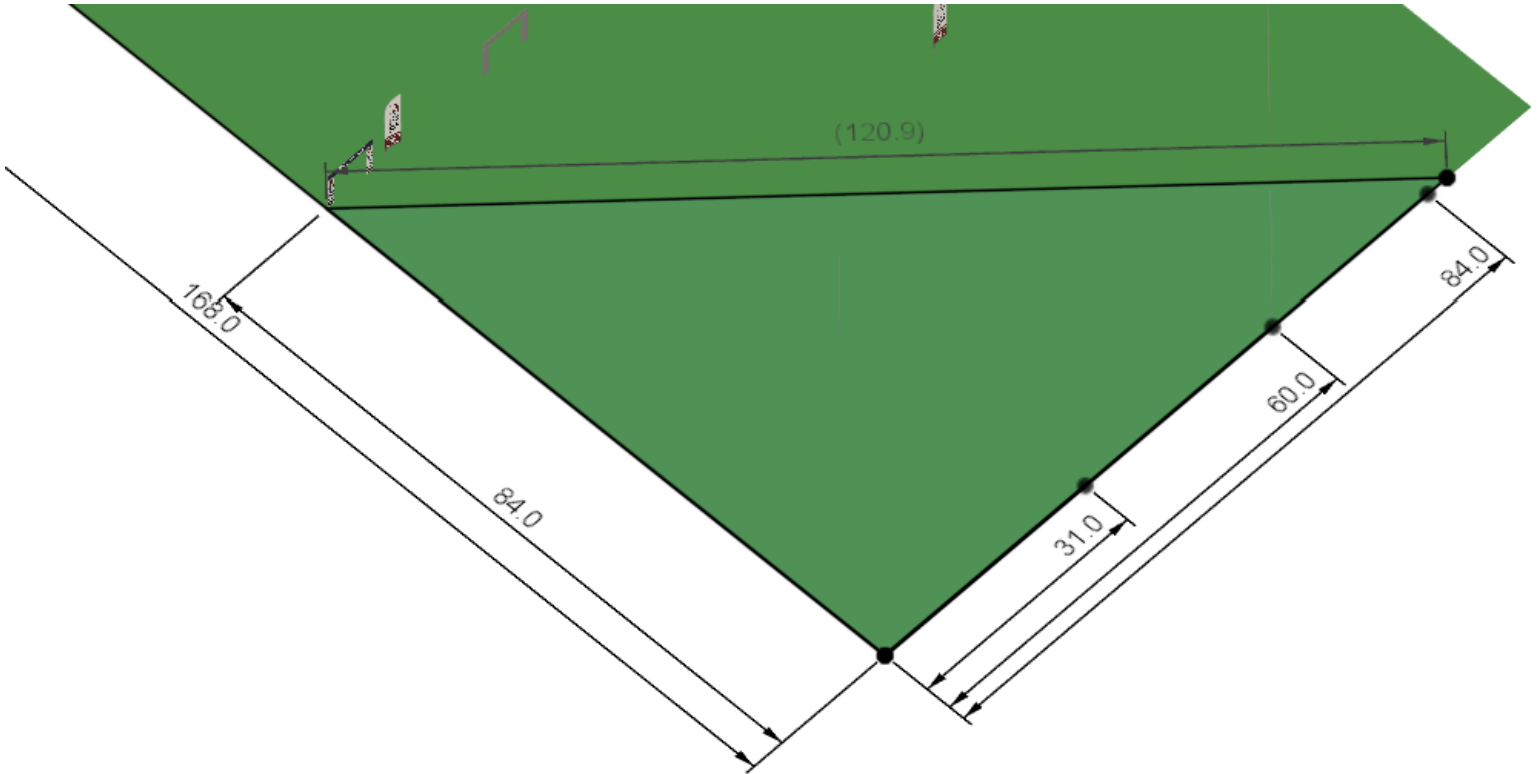

#### Step 4

We are now going to get the location for the 2 gates and flag. Take one tape measure and go to the 84 foot gate rebar and walk out 89.5 feet. Then with the other tape measure walk 31 feet from the 168 foot mark. Where these 2 meet place a gate rebar.

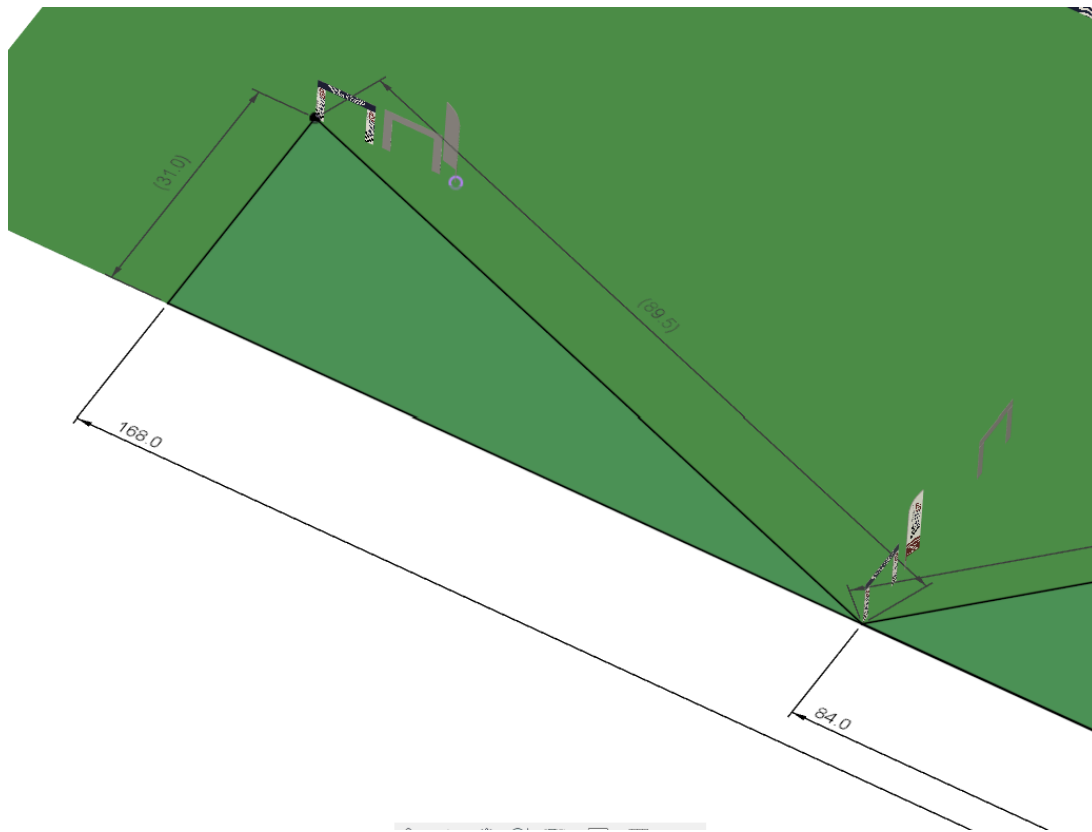



### Step 7

From the zero mark walk out 89.5 ft and from the 84 foot mark walk up 31 ft. Where these meet, gate rebar. Then place a gate rebar at 24 feet, and 7 feet. If you are going to use a feather flag, then place a gate spike at 9 ft. You may also use a flag on the edge of the gate here as well.

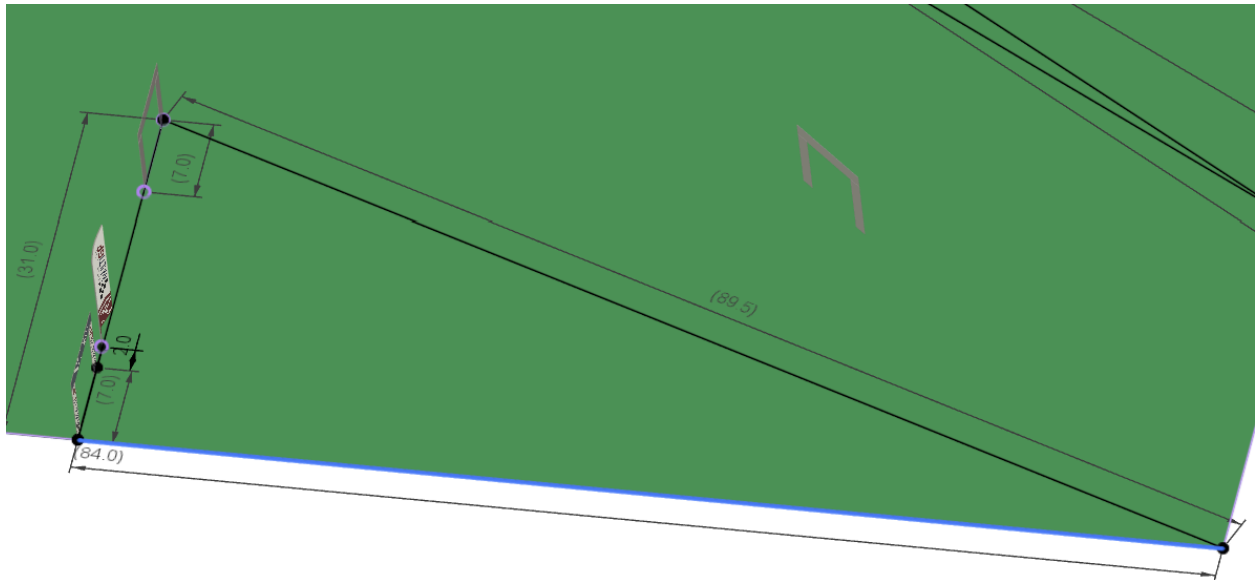

### Step 8

From the 31 foot mark walk out 99.3 feet. Then from the 84 foot mark walk out 84 feet, where these meet place a flag stake. Now from the 31 foot mark walk out 58.7 ft and from the 60 foot mark walk out 51.0 feet. Where these meet, flag stake.

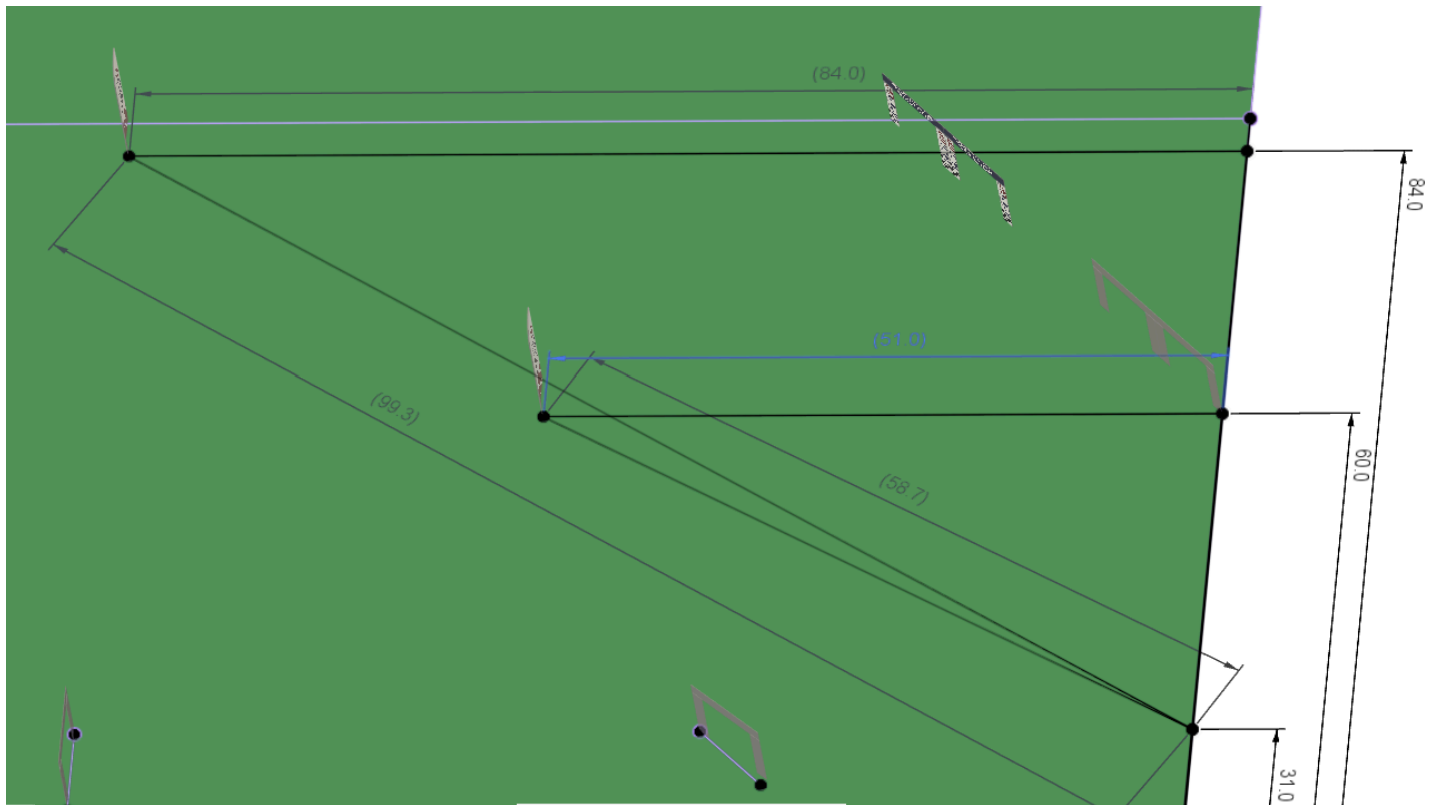

### Step 9

Now we are going to set up the 4 gates in a row. From the 60 foot gate rebar, walk out 38.2 ft. From the 87 ft mark, walk out 27 feet. Where the tapes meet, place a gate rebar. Now along the diagonal line the gates will go on, place a gate rebar at 7ft, 8ft,15ft,23.2,30.2ft,31.2ft.

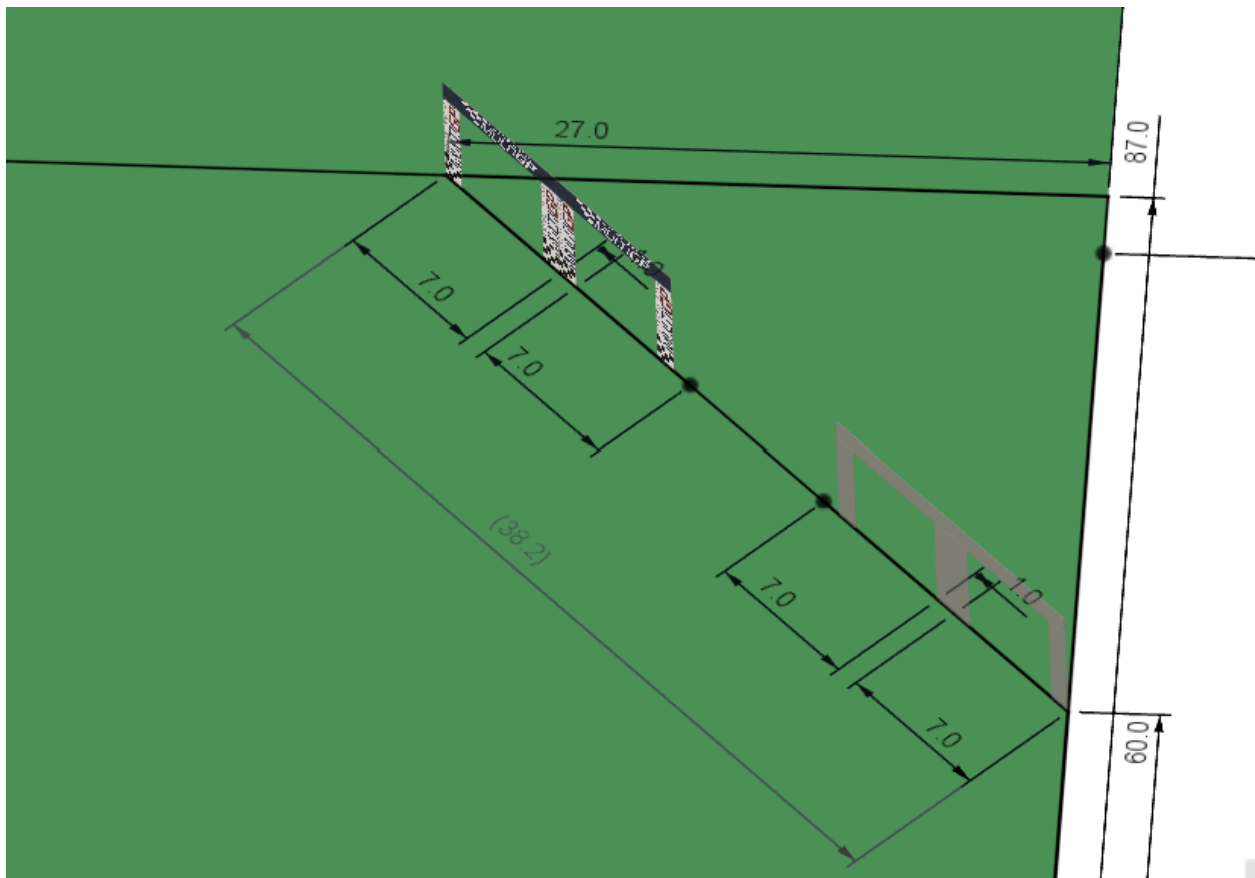

### Step 10

We have one obstacle left, and by now you really love triangles or hate them! From the 87 ft mark walk out into the field 116 ft. Take the other tape measure and go to the 2 gates and flag you set up at the far end of the track. Place the tape measure on at the leg of the gate, NOT the flag, and then walk out 67.1 ft. Where these 2 meet place a gate rebar for the gate. You can also place a rebar for the hurdle here, as well.

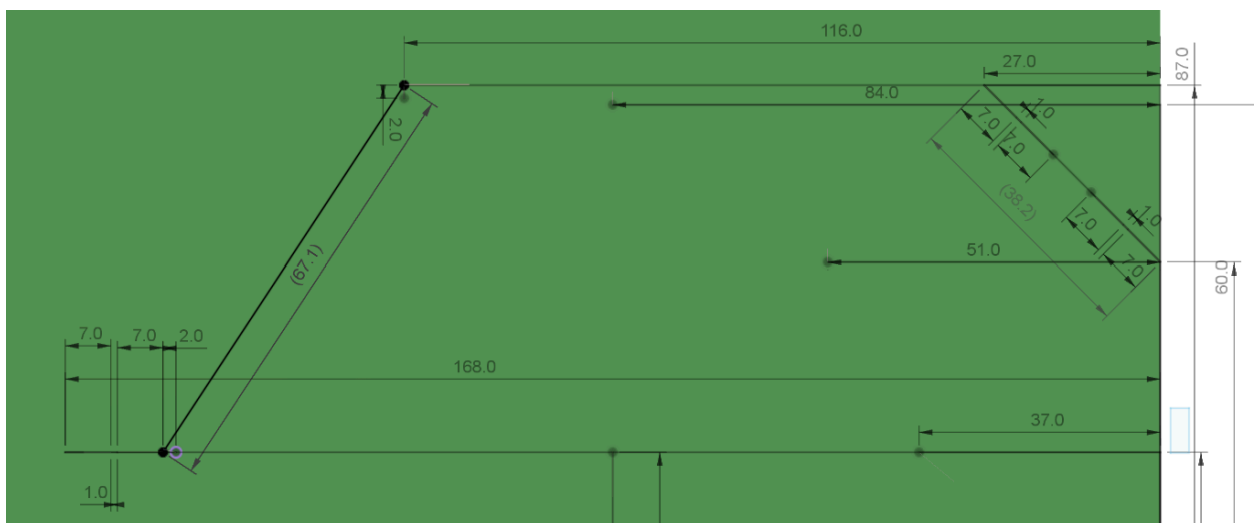

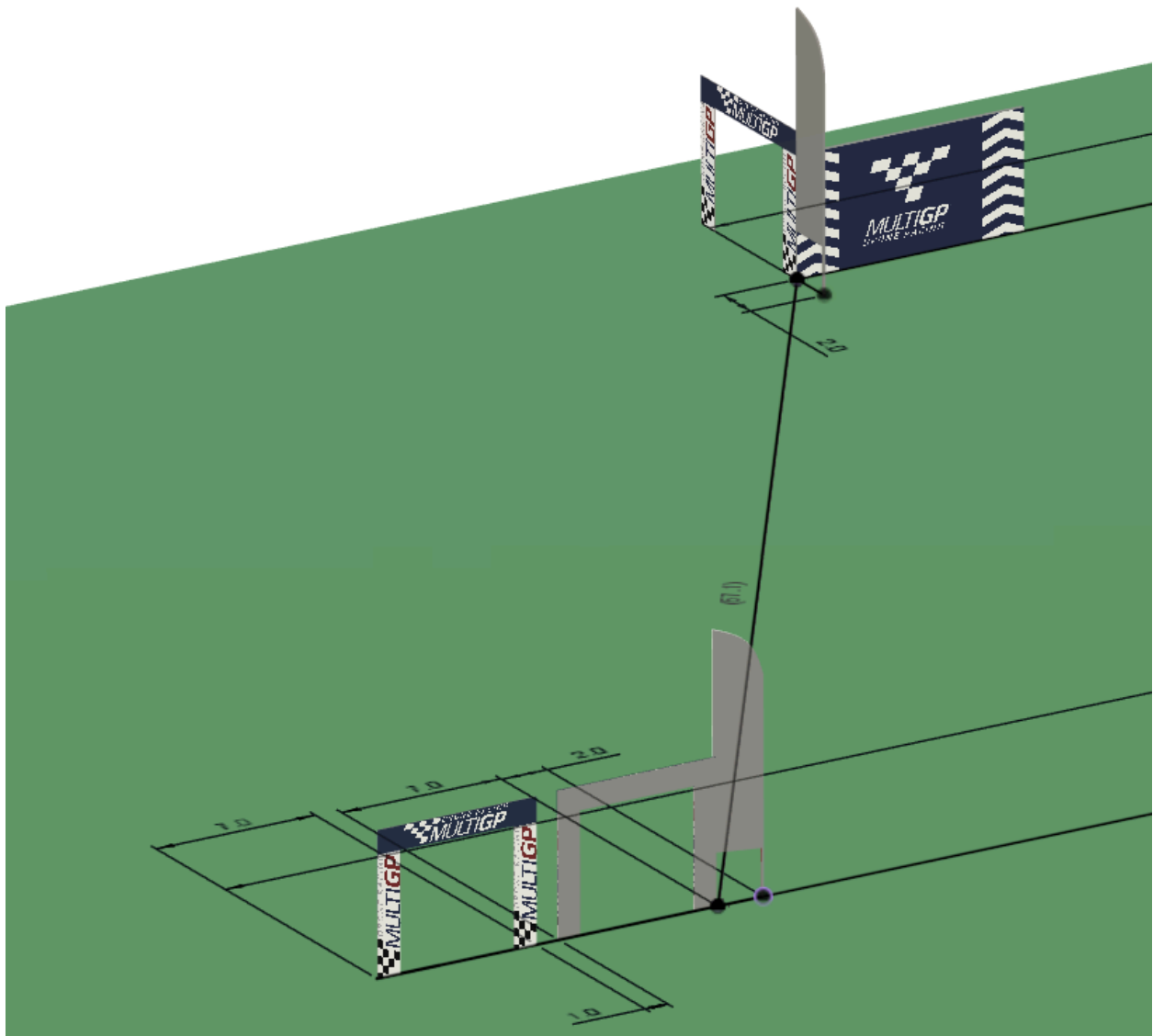

On the line from the 87 ft mark, walk back down the line 10 ft and place a rebar for the hurdle, 106 ft on the tape. Now to square the gate, walk 12.2 ft from the 106 ft mark for the hurdle out to meet the 7 ft line from the gate rebar you placed. Here is the last gate leg, place a rebar. If you are going to place a feather flag, place it 2 ft from the gate. You may also use a flag on the gate for this obstacle. When done it should look like this.

